

Prénom :

## Mon fichier de calcul n° 1

Le travail se réalise en autonomie.

























Je peux le prendre quand j'ai fini  
un travail, quand j'ai un peu de  
temps.

Je le complète au crayon de papier ; les consignes ne sont pas écrites : je dois trouver seul ce qu'il faut faire.





Chaque semaine, je dois avoir réalisé (*au minimum*) 4 exercices au choix : la maîtresse ramasse le fichier tous les jeudis soirs. (A corriger et à faire signer durant le week-end.)

7	-		+	4	=	8
-		+		+		+
2	x	1	x		=	8
+		+		x		+
	+		+		=	8
=		=		=		=
8	+	8	+	8	=	24

Date :

				<b>8</b>
				<input type="radio"/>
				<b>14</b>
				<b>8</b>
				<input type="radio"/>
				<input type="radio"/>

**15**

 \_\_\_\_\_  
 \_\_\_\_\_  
 \_\_\_\_\_  
 \_\_\_\_\_

Date :

$7 \times \square \rightarrow \square$   
 $\square \times 7 \rightarrow 56$   
 $\square + 28 \rightarrow \square$

$\square \times 6 \rightarrow 12$   
 $6 \times \square \rightarrow \square$   
 $\square + \square \rightarrow 30$

Date :

**23**  $3 \ 6 \ 7$   
 $7$

**22**  $\begin{matrix} \square \\ \square \\ 7 \\ \square \end{matrix}$

2	3	6	7
4	7	7	8
6	4	5	7
5	9	7	2

**19**  $\begin{matrix} \square \\ \square \\ 7 \\ \square \end{matrix}$

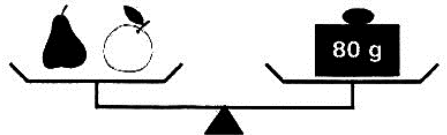

**25**  $\begin{matrix} \square \\ \square \\ \square \\ \square \\ 7 \end{matrix}$

Date :







 \_\_\_\_\_  
 \_\_\_\_\_  
 \_\_\_\_\_

Date :

**40**  $36 + 4$

$80 : 2$

$2 \times 20$

**19**

**20**

2	20	$48 - 8$	90	2		
17	23	50	50	56	20	4
20	20	10	20	16	20	10
26	90	120	70	30	10	4
14	50	3	20	14	26	10
80	2	16	24	26	14	30

Date :

**+**  $2+3=5$        $1+3=4$        $3+10=13$

**-**  $7-2=5$        $8-4=4$        $3-2=1$

$2+10=12$        $11+3=14$        $7+8=15$

$7+6=13$        $4+5=9$        $3+2=5$

$12+8=20$        $4+5=9$        $3+11=14$

$7+2=9$        $8+1=9$        $4+14=18$

Date :

$\begin{array}{r} \text{O} \quad 5 \quad 1 \\ \times \quad 3 \quad 5 \\ \hline \end{array}$

$\begin{array}{r} 3 \quad 2 \quad 5 \quad \text{O} \\ 1 \quad \text{O} \quad 5 \quad \text{O} \\ \hline 2 \quad 2 \quad \text{O} \quad 8 \quad \text{O} \end{array}$

Date :

**+-**    14 12 6      **+-**    13 9 7

**8** →  $14 - 12 + 6$       **11** → \_\_\_\_\_

**+-**    12 14 13      **+-**    16 2 12

**13** → \_\_\_\_\_      **6** → \_\_\_\_\_

Date :

**27**     $\begin{array}{|c|c|c|} \hline & & \\ \hline & & \\ \hline \end{array}$       **6**     $\begin{array}{|c|} \hline \\ \hline \\ \hline \end{array}$       **22**

$\begin{array}{|c|c|c|c|} \hline 5 & 4 & 8 & 6 \\ \hline 3 & 9 & 6 & 3 \\ \hline 9 & 7 & 2 & 8 \\ \hline 8 & 9 & 6 & 5 \\ \hline \end{array}$

**24**     $\begin{array}{|c|} \hline \\ \hline \\ \hline \\ \hline \end{array}$       **9**     $\begin{array}{|c|c|c|} \hline & & \\ \hline & & \\ \hline \end{array}$       **25**

Date :

6	+		+	2	=	13
+		+		+		-
	+		-	6	=	4
+		+		+		+
	+	1	+		=	9
=		=		=		=
18	+		-	10	=	

Date :

				<input type="radio"/>
				<b>15</b>
				<b>19</b>
				<input type="radio"/>
				<b>12</b>
				<input type="radio"/>
<input type="radio"/>	<b>20</b>	<b>30</b>	<input type="radio"/>	

\_\_\_\_\_

\_\_\_\_\_

\_\_\_\_\_

\_\_\_\_\_

Date :

30

7		8	6	6
	3	8	5	5
		4	8	7
5	7		7	
7	8			7

Date :

34

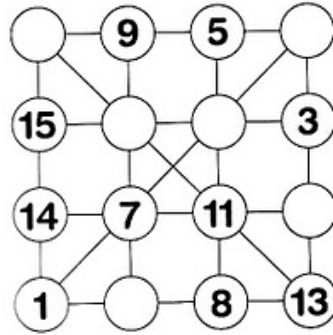

34

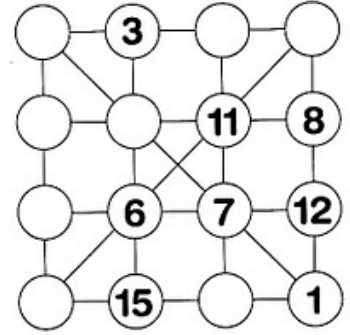

Date :

+

1	3	4
9	-	5
7	-	3

7	3	12
4	6	2

2	8	10
3	7	0

-

10	2	5
9	1	3

12	3	5
4	6	2

7	8	3
4	15	4

12	3	20
7	8	5

4	9	16
15	2	3

3	12	10
16	1	5

Date :

12

6	4 x 3	7	14 - 2	16		
6	4	8	6	15	11	4
5	2	10	6	3	2	5
7	2	6	3	4	9	17
13	1	10	13	15	3	8
8	4	2	3	4	5	4

Date :

○

6

7

○

18

○

- \_\_\_\_\_
- \_\_\_\_\_
- \_\_\_\_\_
- \_\_\_\_\_

12

○

15

○

Date :

	+	4	+	2	=	9
+		+		+		
9	+		-	3	=	7
-		-		-		
	+	5	+		=	9
=		=		=		=
10		0		3	=	7

Date :

38

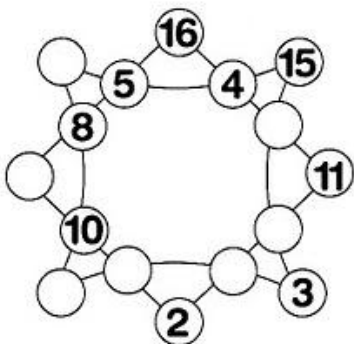

34

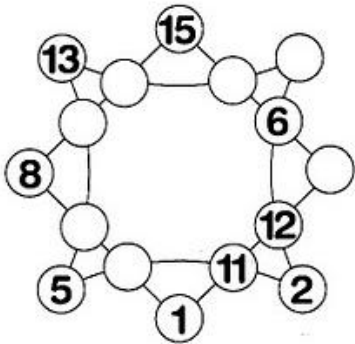

Date :

+

3	3	9
6	3	5

8	9	20
3	15	4

6	2	9
3	4	3

X

7	3	3
20	1	18

2	3	6
4	5	2

4	12	4
4	15	1

6	32	4
6	29	7

14	7	4
2	19	9

3	10	2
4	5	7

Date :

+ -

10 8 7

+ -

12 3 11

9 → \_\_\_\_\_

20 → \_\_\_\_\_

+ -

4 5 7

+ -

15 3 10

2 → \_\_\_\_\_

8 → \_\_\_\_\_

Date :

🍏	🍊	🍏	🍇
🍒	🍊	🍒	🍏
🍒	🍊	🍇	🍏
🍊	🍊	🍇	🍇
🍊	🍊	🍇	🍇
🍒	🍊	🍒	🍏

19

○

🍇 \_\_\_\_\_

○

🍊 \_\_\_\_\_

15

○

🍒 \_\_\_\_\_

22

🍏 \_\_\_\_\_

32 18 34 ○

Date :

+

8 ○ 5 ○ 2 = 42

-

8 ○ 5 ○ 2 = 15

X

8 ○ 5 ○ 2 = 1

8 ○ 5 ○ 2 = 11

8 ○ 5 ○ 2 = 38

8 ○ 5 ○ 2 = 26

Date :

26

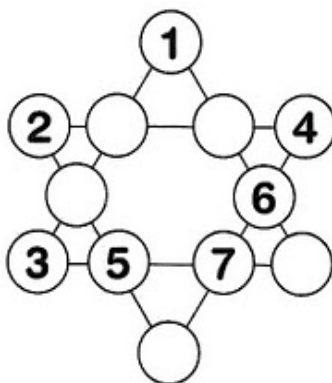

26

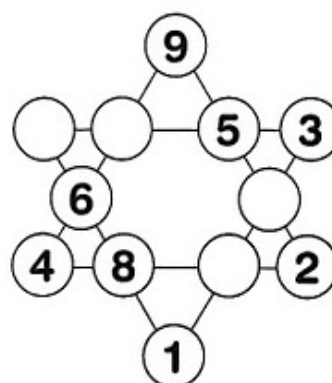

Date :

**15**

<del>3</del>	<del>2</del>	<del>10</del>	7	4	4	5
7	5	3	3	6	6	4
5	8	5	5	5	6	3
6	4	5	6	7	3	8
7	3	6	5	9	1	7
2	10	0	5	8	8	5
6	3	9	4	4	7	4

Date :

○	○	7	2
	x	5	○
<hr/>			
	8	1	4
○	0	○	6
<hr/>			
2	○	1	○

Date :

**+**      **9**

**x**      **4 + 5**

3	x	3
6	+	3

8	9	6
3	15	4

6	2	9
3	4	3

7	3	3
20	1	18

2	3	6
4	5	2

4	12	4
4	15	1

6	32	4
6	29	7

14	7	4
2	19	9

2	24	2
13	19	7

Date :

**-6**      **x3**      **-10**      **x5**

12	6	36	21
36	18	24	30
30	12	36	84
24	72	30	90

15	125	65	55
5	25	15	35
35	65	75	95
45	85	65	325

Date :

17 + 12 =	<b>19</b>	19 + 23 =	<b>32</b>
	<b>29</b>		<b>42</b>
	<b>39</b>		<b>52</b>
51 + 22 =	<b>83</b>	18 + 18 =	<b>16</b>
	<b>73</b>		<b>26</b>
	<b>63</b>		<b>36</b>
28 + 12 =	<b>20</b>	32 + 17 =	<b>29</b>
	<b>30</b>		<b>39</b>
	<b>40</b>		<b>49</b>





























Date :

	○ _____
	● _____
	● _____

Date :

5	+		+	2	=	15
x		+		+		+
	+		-	1	=	
-		-		x		-
	+	5	+		=	15
=		=		=		=
	-	15	+	15	=	15

Date :

				<input type="radio"/>	
				6	 _____
				7	 _____
				<input type="radio"/>	 _____
				18	 _____
				<input type="radio"/>	

12  15

Date :

<b>+</b>	7	<input type="radio"/>	5	<input type="radio"/>	2 = 10
<b>-</b>	7	<input type="radio"/>	5	<input type="radio"/>	2 = 14
<b>x</b>	7	<input type="radio"/>	5	<input type="radio"/>	2 = 0
	7	<input type="radio"/>	5	<input type="radio"/>	2 = 4
	7	<input type="radio"/>	5	<input type="radio"/>	2 = 37
	7	<input type="radio"/>	5	<input type="radio"/>	2 = 70

Date :

24

12	4 x 6	14	28 - 4	32
+	8	16	12	30
12	22	8		
10	4	20	12	6
4	12	6	16	18
34				
26	2	20	26	30
6	16			
16	8	4	6	8
2	8			
29	1	2	14	3
26	20			

Date :

7	x		→				x	7	→	63
x		x		+		x		x		+
	x	7	→	56		8	x		→	
56	+	63	→				+	63	→	135

Date :

17 - 12 =	5	39 - 23 =	16
	15		26
	9		36
51 - 23 =	18	38 - 19 =	39
	38		29
	28		19
28 - 12 =	16	32 - 17 =	35
	26		25
	36		15

Date :